







KSR 6 SERIES

KSR-616

World's Best Company in Digital Video Recording
Kodicom provides high quality display pictures with outstanding recording speed.



Main Functions

- 
REAL TIME MONITORING
Simultaneous live images
- 
COMPACT PICTURE STORAGE
Images are compressed to an average file size between 2-10Kb per picture using MPEG4 Algorithm
- 
EASY PICTURE RETRIEVAL
Instant picture retrieval by date /time and camera number
- 
EVENT CONTROLLED RECORDING
Reduces the amount of data and automatically records specific events
- 
REMOTE CONTROL
Remote Control of PTZ cameras & other electronic devices
- 
PICTURE TRANSMISSION OVER NETWORK
High quality picture transmission over PSTN, ISDN & LAN network
- 
MULTI SCREEN MONITORING
1, 4, 9, 16 Split Screen available

Digital Video Recorder(Non-PC based)

KSR-616 Hot

Front/ Rear View



Features

- High Quality Realtime Display – Max. 480fps(NTSC) 400fps(PAL)
- High Quality and High Speed Recording – Max. 120fps(NTSC) 100(PAL)
- Various Resolutions on Display and Recording – 704×480, 704×240, 352×240(NTSC), 704×576, 704×288, 352×288(PAL)
- MPEG4
- 1, 4, 9, 16 Division
- Kodicom, Pelco, Dennard, Bosch, Samsung and many more PTZ protocol included
- Watermark Function
- Remote Observation Through Network
- Emergency Screen Auto Transfer to Center Software
- User friendly Graphic User Interface
- Watchdog Function
- Mouse control supports

External Specification

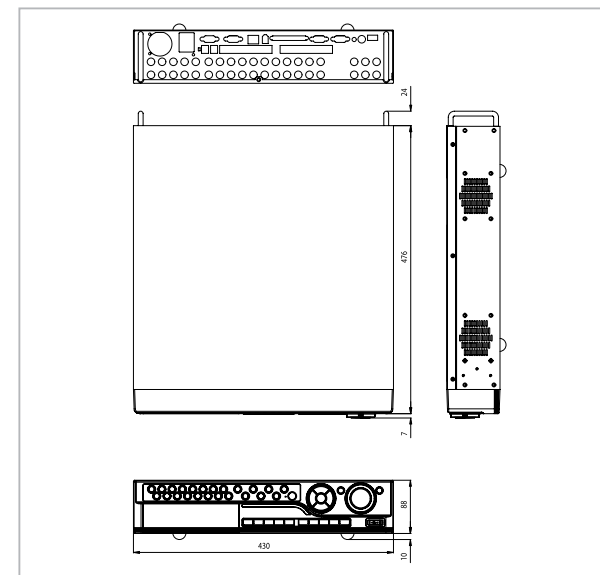

Specifications

Model		KSR-616
Display	Speed	NTSC : 480fps PAL : 400fps
	Screen Division	1, 4, 9, 16 Division
Recording	Max. Speed (@CIF)	NTSC : 120fps PAL : 100fps
	Resolution	NTSC : 704×480, 704×240, 352×240 PAL : 704×576, 704×288, 352×288
	Recording Option	Continuous, Motion, Sensor, Pre-Alarm
Video	Format	NTSC/PAL
	CODEC	MPEG4
Input	Input	16 Ports
	Output	VGA, CVBS, S-Video, Programmable spot out (1ch quad, 4ch full)
Audio	Input	8ch (line input)
	Output	1ch
CODEC	CODEC	ADPCM
	Output	16 Ports
Alarm	Input	16 Ports
	Output	16 Ports
Network	Transmission	Ethernet (RJ45), PSTN (optional)
	Protocol	TCP/IP (support dynamic IP)
Backup	Device	USB, Network, IEEE1394, CD/DVD-RW
Other Function	Remote Control	Remote Software (CMS)
	Remote Alarm	E-mail, CMS report
	PTZ	RS232C/485
	Watch Dog Function	Yes
	Image Authentication	Watermark
	Language	10 Languages
	Password	Multi-Level User Password Authorization
USB	2 Ports (USB2.0)	
Working Temperature	0°C ~ +40°C	
Power Source	AC 100 ~ 240V, 50/60Hz	
Dimensions	430mm(W) × 88mm(H) × 483mm(D)	
Weight (net)	10.5Kg (23.1lbs)	

*Specifications subject to change without notice.

Functions by Screen



Application

Some recommended installation areas are Securities Companies, Change Booths, Casinos, Pawnshops, Jewelers, Galleries, Exhibition Halls, Department Stores, Convenience Stores, Discount Offices, Hospital, Police Stations, Subway Stations, Airports, Banks etc.