







# KSR 7 SERIES

## KSR-716

World's Best Company in Digital Video Recording  
Kodicom provides high quality display pictures with outstanding recording speed.



### Main Functions

- 
**REAL TIME MONITORING**  
Simultaneous live images
- 
**COMPACT PICTURE STORAGE**  
Images are compressed to an average file size between 2-10Kb per picture using MPEG4 Algorithm
- 
**EASY PICTURE RETRIEVAL**  
Instant picture retrieval by date /time and camera number
- 
**EVENT CONTROLLED RECORDING**  
Reduces the amount of data and automatically records specific events
- 
**REMOTE CONTROL**  
Remote Control of PTZ cameras & other electronic devices
- 
**PICTURE TRANSMISSION OVER NETWORK**  
High quality picture transmission over PSTN, ISDN & LAN network
- 
**MULTI SCREEN MONITORING**  
1, 4, 9, 16 Split Screen available

Digital Video Recorder(Non-PC based)

**KSR-716** Hot

### Front/ Rear View



### Features

- High Quality Realtime Display – Max. 480fps(NTSC) 400fps(PAL)
- High Quality and High Speed Recording – Max. 240fps(NTSC) 200(PAL)
- Various Resolutions on Display and Recording – 704×480, 704×240, 352×240(NTSC), 704×576, 704×288, 352×288(PAL)
- MPEG4
- 1, 4, 9, 16 Division
- Kodicom, Pelco, Dennard, Bosch, Samsung and many more PTZ protocol included
- Watermark Function
- Remote Observation Through Network
- Emergency Screen Auto Transfer to Center Software
- User friendly Graphic User Interface
- Watchdog Function
- Mouse control supports

### External Specification

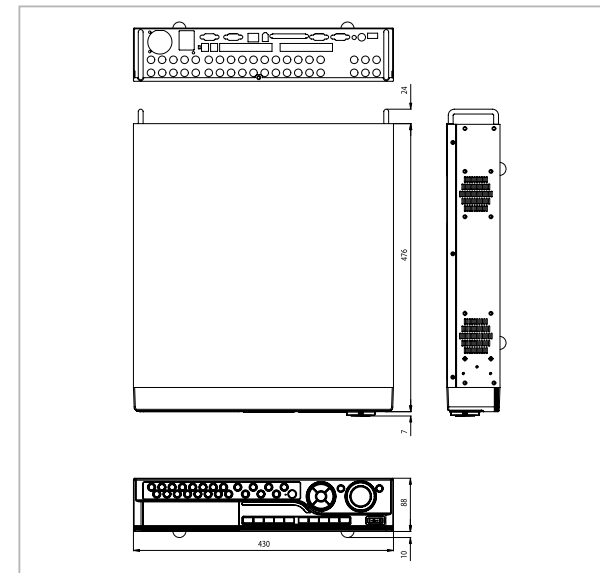

### Specifications

| Model               |                               | KSR-716   |
|---------------------|-------------------------------|---|
| Display             | Speed                         | NTSC : 480fps PAL : 400fps  |
|                     | Screen Division               | 1, 4, 9, 16 Division  |
| Recording           | Max. Speed (@CIF)             | NTSC : 240fps PAL : 200fps  |
|                     | Resolution                    | NTSC : 704×480, 704×240, 352×240<br>PAL : 704×576, 704×288, 352×288 |
|                     | Recording Option              | Continuous, Motion, Sensor, Pre-Alarm                               |
| Video               | Format                        | NTSC/PAL  |
|                     | CODEC                         | MPEG4   |
| Input               | Input                         | 16 Ports  |
|                     | Output                        | VGA, CVBS, S-Video, Programmable spot out (1ch quad, 4ch full)      |
| Audio               | Input                         | 16ch (line input)   |
|                     | Output                        | 1ch   |
| CODEC               | Input                         | ADPCM   |
|                     | Output                        | ADPCM   |
| Alarm               | Input                         | 16 Ports  |
|                     | Output                        | 16 Ports  |
| Network             | Transmission                  | Ethernet (RJ45), PSTN (optional)                                    |
|                     | Protocol                      | TCP/IP (support dynamic IP)   |
| Backup              | Device                        | USB, Network, IEEE1394, CD/DVD-RW                                   |
| Other Function      | Remote Control                | Remote Software (CMS)   |
|                     | Remote Alarm                  | E-mail, CMS report  |
|                     | PTZ                           | RS232C/485  |
|                     | Watch Dog Function            | Yes   |
|                     | Image Authentication          | Watermark   |
|                     | Language                      | 10 Languages  |
|                     | Password                      | Multi-Level User Password Authorization                             |
|                     | USB                           | 2 Ports (USB2.0)  |
| Working Temperature | 0°C ~ +40°C                   |   |
| Power Source        | AC 100 ~ 240V, 50/60Hz        |   |
| Dimensions          | 430mm(W) × 88mm(H) × 483mm(D) |   |
| Weight (net)        | 10.5Kg (23.1lbs)              |   |

\*Specifications subject to change without notice.

### Functions by Screen



### Application

Some recommended installation areas are Securities Companies, Change Booths, Casinos, Pawnshops, Jewelers, Galleries, Exhibition Halls, Department Stores, Convenience Stores, Discount Offices, Hospital, Police Stations, Subway Stations, Airports, Banks etc.